



Solutions sur mesure pour votre usinage
Machining solutions especially for you

& FRAISES ALÉSOIRS

Carbure Brasé



Sommaire

■ Fraises Hélicoïdales

- 2 dents - Coupe au centre – hélice à 25° **Page 03**
- 2 dents - Coupe au centre – hélice à 35° **Page 03**
- 2 dents – Coupe au centre – hélice 25° pour travail des alliages légers **Page 04**
- 3 dents mini - hélice à 25° **Page 05**
- 3 dents mini - hélice à 45° **Page 05**
- Revêtues TIN & TICN – hélice à 25° **Page 06**
- Hémisphériques - Coupe au centre **Page 07**

■ Fraises de Forme

- Fraise Conique à 50° - 55° & 60° **Page 08**
- Fraise pour rainure à T **Page 08**

■ Fraises 3 Tailles

- Fraise 3 Tailles à Alésage **Page 09**

■ Alésoirs

- Alésoirs Creux Conique 1/30 **Page 10**
- Alésoirs QC lisse **Page 11**
- Alésoirs Cône Morse **Page 11**

■ Outils carbure Brasés Spéciaux

- Réalisation de dimensions hors standard sur demande

Fraise Finition
Hélice à 25°
(nuance K10)

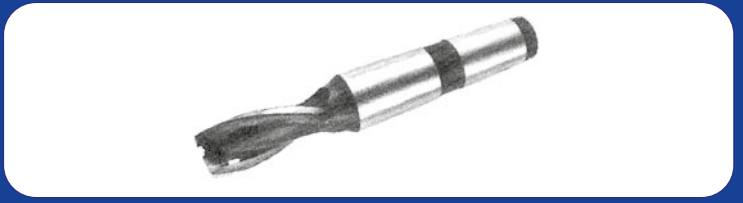

QC Weldon DIN 1835B

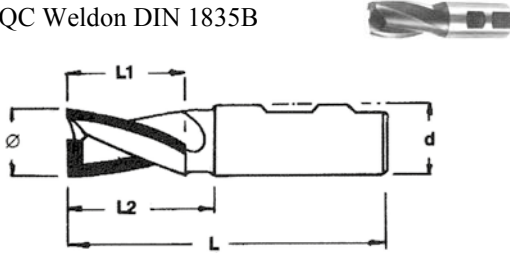

Code	Ø e8	L	L1	L2	d h8	Z	Prix Euros
2 95 100 16	16	95	30	47	16	2	
2 95 100 18	18	115	40	59	20	2	
2 95 100 20	20	115	40	59	20	2	
2 95 100 22	22	118	50	62	25	2	
2 95 100 25	25	118	50	62	25	2	Nous
2 95 100 28	28	121	50	65	25	2	
2 95 100 32	32	125	50	65	32	2	Consulter
2 95 100 36	36	145	63	85	32	2	
2 95 100 40	40	145	63	85	32	2	
2 95 100 50	50	170	80	110	32	2	

Cône Morse taraudé

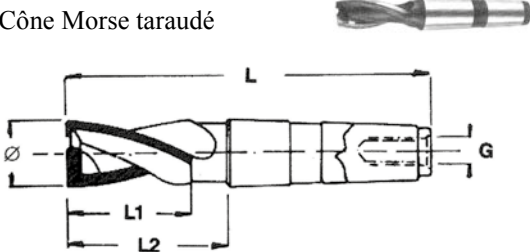

Code	Ø e8	L	L1	L2	G	CM	Z	Prix Euros
2 95 101 16	16	115	30	47	M10	2	2	
2 95 101 18	18	145	40	59	M12	3	2	
2 95 101 20	20	145	40	59	M12	3	2	Nous
2 95 101 22	22	160	50	74	M12	3	2	
2 95 101 25	25	160	50	74	M12	3	2	Consulter
2 95 101 28	28	166	50	80	M12	3	2	
2 95 101 32	32	200	50	90	M16	4	2	
2 95 101 36	36	215	63	105	M16	4	2	
2 95 101 40	40	215	63	105	M16	4	2	
2 95 101 50	50	224	80	115	M16	4	2	

Fraise FINITION
Hélice à 35°
(nuance K10)



QC Weldon DIN 1835B

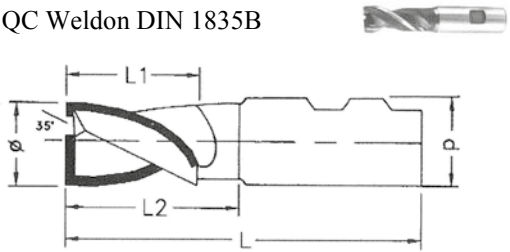

Code	Ø e8	L	L1	L2	d h8	Z	Prix Euros
2 95 200 16	16	95	30	47	16	2	
2 95 200 18	18	115	40	59	20	2	
2 95 200 20	20	115	40	59	20	2	
2 95 200 22	22	118	50	62	25	2	
2 95 200 25	25	118	50	62	25	2	Nous
2 95 200 28	28	121	50	65	25	2	
2 95 200 32	32	125	50	65	32	2	Consulter
2 95 200 36	36	145	63	85	32	2	
2 95 200 40	40	145	63	85	32	2	
2 95 200 50	50	170	80	110	32	2	

Cône Morse taraudé

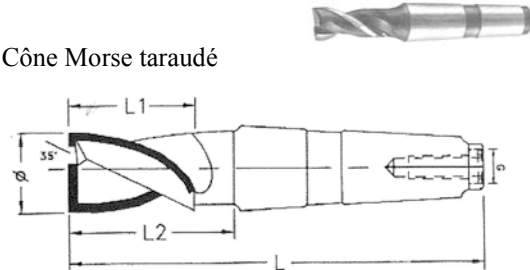

Code	Ø e8	L	L1	L2	G	CM	Z	Prix Euros
2 95 201 16	16	115	30	47	M10	2	2	
2 95 201 18	18	145	40	59	M12	3	2	
2 95 201 20	20	145	40	59	M12	3	2	
2 95 201 22	22	160	50	74	M12	3	2	
2 95 201 25	25	160	50	74	M12	3	2	Nous
2 95 201 28	28	166	50	80	M12	3	2	
2 95 201 32	32	200	50	90	M16	4	2	Consulter
2 95 201 36	36	215	63	105	M16	4	2	
2 95 201 40	40	215	63	105	M16	4	2	
2 95 201 50	50	224	80	115	M16	4	2	

■ Fraises Hélicoïdales Usinage des Alliages Légers

z2 - coupe au centre

Fraise Finition Usinage des alliages Légers Hélice à 25° (nuance K10)

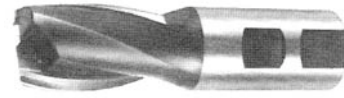

QC Weldon DIN 1835B

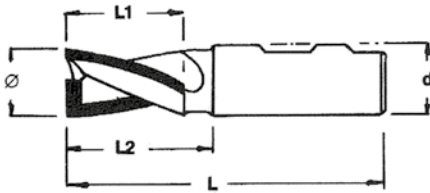

Code	Ø e8	L	L1	L2	d h8	Z	Prix Euros
2 95 305 16	16	88	25	40	16	2	
2 95 305 16	16	103	40	55	16	2	
2 95 305 20	20	105	40	55	20	2	
2 95 305 20	20	115	50	65	20	2	
2 95 305 25	25	116	45	60	25	2	Nous
2 95 305 25	25	134	63	78	25	2	
2 95 305 32	32	125	50	65	32	2	Consulter
2 95 305 32	32	155	80	95	32	2	
2 95 305 40	40	140	50	70	40	2	
2 95 305 40	40	170	80	100	40	2	

Cône Morse taraudé

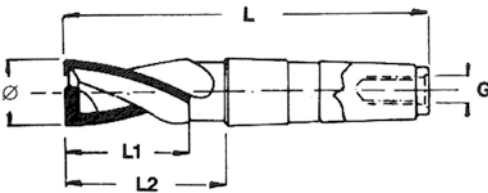

Code	Ø e8	L	L1	L2	G	CM	Z	Prix Euros
2 95 306 16	16	116	32	47	M10	2	2	
2 95 306 18	16	124	40	55	M10	2	2	
2 95 306 20	20	143	40	57	M12	3	2	
2 95 306 22	20	153	50	67	M12	3	2	
2 95 306 25	25	146	45	60	M12	3	2	Nous
2 95 306 28	25	166	63	80	M12	3	2	
2 95 306 32	32	172	50	63	M16	4	2	Consulter
2 95 306 36	32	202	80	93	M16	4	2	
2 95 306 40	40	172	50	63	M16	4	2	
2 95 306 40	40	222	100	113	M16	4	2	
2 95 306 50	50	172	50	63	M16	4	2	
2 95 306 50	50	222	100	113	M16	4	2	
2 95 306 63	63	212	90	103	M16	4	2	

Cône SA DIN 2080

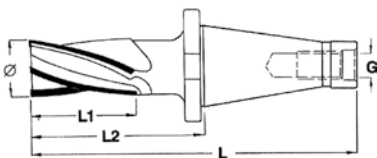

Code	Ø e8	L	L1	L2	d h8	Z	Prix Euros
2 95 307 32	32	173	50	70	32	2	
2 95 307 32	32	223	100	120	32	2	
2 95 307 40	40	173	50	70	40	2	Nous
2 95 307 40	40	262	100	120	40	2	
2 95 307 50	50	173	50	70	50	2	Consulter
2 95 307 50	50	282	120	140	50	2	
2 95 307 63	63	186	63	83	63	2	
2 95 307 63	63	312	150	170	63	2	

Cône CAT DIN 69871

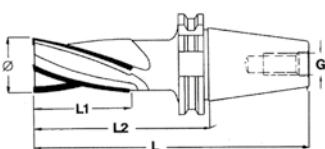

Code	Ø e8	L	L1	L2	d h8	Z	Prix Euros
2 95 308 32	32	158	50	70	32	2	
2 95 308 32	32	208	100	120	32	2	
2 95 308 40	40	158	50	70	40	2	Nous
2 95 308 40	40	241	100	120	40	2	
2 95 308 50	50	158	50	70	50	2	Consulter
2 95 308 50	50	261	120	140	50	2	
2 95 308 63	63	171	63	83	63	2	
2 95 308 63	63	291	150	170	63	2	

Fraise Finition Hélice à 25° (nuance K10/P25)



QC Weldon DIN 1835B

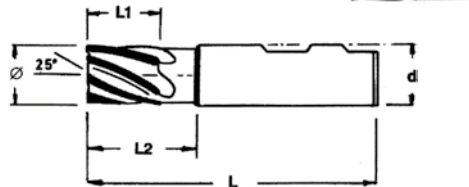

Cône Morse taraudé

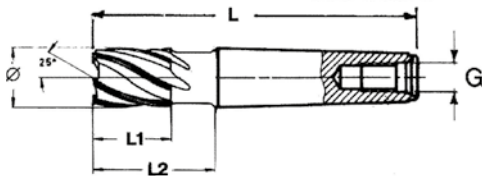

Cône SA DIN 2080

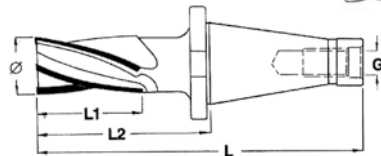

Cône CAT DIN 69871

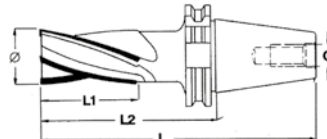

Fraise à Alésage

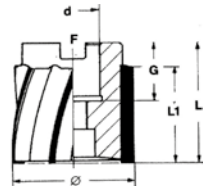

Code	Ø e8	L	L1	L2	d h8	Z	Prix Euros
2 95 300 16	16	95	30	47	16	3	
2 95 300 18	18	109	40	59	20	3	
2 95 300 20	20	115	40	59	25	3	Nous
2 95 300 22	22	118	50	62	25	4	
2 95 300 25	25	118	50	62	25	4	consulter
2 95 300 28	28	121	50	65	25	4	
2 95 300 32	32	125	50	65	32	4	
2 95 300 36	36	130	50	70	32	5	
2 95 300 38	38	135	50	75	32	6	
2 95 300 40	40	145	63	85	32	6	

Code	Ø e8	L	L1	L2	G	CM	Z	Prix Euros
2 95 301 16	16	116	30	47	M10	2	3	
2 95 301 18	18	145	40	59	M12	3	3	
2 95 301 20	20	145	40	59	M12	3	3	Nous
2 95 301 22	22	160	50	74	M12	3	4	
2 95 301 25	25	160	50	74	M12	3	4	consulter
2 95 301 28	28	166	50	80	M12	3	4	
2 95 301 32	32	200	50	80	M16	4	4	
2 95 301 36	36	200	50	90	M16	4	5	
2 95 301 40	40	215	63	95	M16	4	6	

Code	Ø e8	L	L1	L2	G	SA	Z	Prix Euros
2 95 302 32	32	180	50	86	M16	40	4	
2 95 302 40	40	200	63	106	M16	40	6	
2 95 302 50	50	228	80	133	M16	40	6	Nous
2 95 302 50	50	260	80	133	M24	50	6	
2 95 302 63	63	280	100	133	M24	50	6	consulter

Code	Ø e8	L	L1	L2	G	CAT	Z	Prix Euros
2 95 303 40	40	180	63	112	M16	40	6	Nous
2 95 303 50	50	200	80	133	M16	40	6	
2 95 303 50	50	235	80	133	M24	50	6	consulter
2 95 303 63	63	260	100	158	M24	50	6	

Code	Ø e8	L	L1	G	F	D h7	Z	Prix Euros
2 95 304 40	40	50	40	24	8.4	16	6	Nous
2 95 304 50	50	50	40	24	10.4	22	6	
2 95 304 63	63	63	50	30	12.4	27	6	consulter
2 95 304 80	80	63	50	34	14.4	32	8	
2 95 304 100	100	80	63	38	16.4	40	8	

Fraise FINITION Hélice à 45°



QC Weldon DIN 1835B

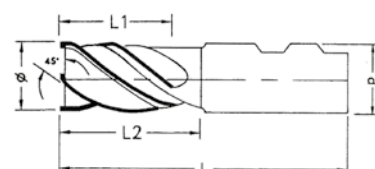

Code	Ø e8	L	L1	L2	d h6	Z	Prix Euros
2 95 400 16	16	95	30	47	16	3	
2 95 400 20	20	115	40	59	25	3	
2 95 400 25	25	118	50	62	25	4	Nous
2 95 400 32	32	125	50	65	32	4	
2 95 400 40	40	145	63	85	32	6	consulter
2 95 400 50	50	157	75	97	32	6	

■ Fraises Hélicoïdales Revêtues

Fraise Finition revêtue TiN Hélice à 25°



TiN Cône morse

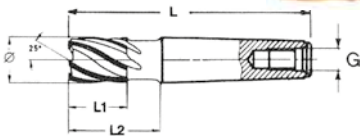

Code	Ø e8	L	L1	L2	G	CM	Z	Prix Euros
2 95 501 16	16	116	30	47	M10	2	3	
2 95 501 18	18	145	40	59	M12	3	3	
2 95 501 20	20	145	40	59	M12	3	3	Nous
2 95 501 22	22	160	50	74	M12	3	4	
2 95 501 25	25	160	50	74	M12	3	4	Consulter
2 95 501 28	28	166	50	80	M16	4	4	
2 95 501 32	32	200	50	80	M16	4	4	
2 95 501 36	36	200	50	90	M16	4	5	
2 95 501 40	40	215	63	95	M16	4	6	

TiN Cône SA din2080

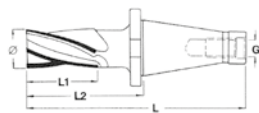

Code	Ø e8	L	L1	L2	G	SA	Z	Prix Euros
2 95 502 32	32	180	50	86	M16	40	4	Nous
2 95 502 40	40	200	63	106	M16	40	6	
2 95 502 50	50	228	80	133	M16	40	6	Consulter
2 95 502 50	50	260	80	133	M24	50	6	
2 95 502 63	63	280	100	153	M24	50	6	

TiN Cône CAT din69871

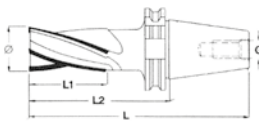

Code	Ø e8	L	L1	L2	G	SA	Z	Prix Euros
2 95 503 40	40	180	63	112	M16	40	6	Nous
2 95 503 50	50	200	80	133	M16	40	6	
2 95 503 50	50	235	80	133	M24	50	6	Consulter
2 95 503 63	63	260	100	158	M24	50	6	

Fraise Finition revêtue TiCN Hélice à 25°



TiCN Cône morse

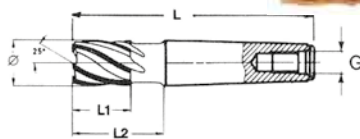

Code	Ø e8	L	L1	L2	G	CM	Z	Prix Euros
2 95 601 16	16	116	30	47	M10	2	3	
2 95 601 18	18	145	40	59	M12	3	3	
2 95 601 20	20	145	40	59	M12	3	3	Nous
2 95 601 22	22	160	50	74	M12	3	4	
2 95 601 25	25	160	50	74	M12	3	4	Consulter
2 95 601 28	28	166	50	80	M16	4	4	
2 95 601 32	32	200	50	80	M16	4	4	
2 95 601 36	36	200	50	90	M16	4	5	
2 95 601 40	40	215	63	95	M16	4	6	

TiCN Cône SA din 2080

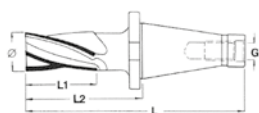

Code	Ø e8	L	L1	L2	G	SA	Z	Prix Euros
2 95 602 32	32	180	50	86	M16	40	4	Nous
2 95 602 40	40	200	63	106	M16	40	6	
2 95 602 50	50	228	80	133	M16	40	6	Consulter
2 95 602 50	50	260	80	133	M24	50	6	
2 95 602 63	63	280	100	153	M24	50	6	

TiCN Cône CAT din69871

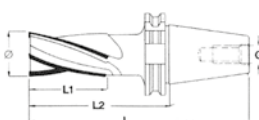

Code	Ø e8	L	L1	L2	G	SA	Z	Prix Euros
2 95 603 40	40	180	63	112	M16	40	6	Nous
2 95 603 50	50	200	80	133	M16	40	6	
2 95 603 50	50	235	80	133	M24	50	6	Consulter
2 95 603 63	63	260	100	158	M24	50	6	

Fraise Finition Hélicoïdale Hémisphérique



QC série Courte

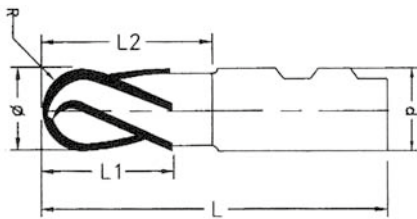

	Ø e8	L	L1	L2	R	d h6	Z	Prix Euros
2 95 700 16	16	95	30	47	8	20	3	Nous
2 95 700 20	20	115	40	59	10	25	3	
2 95 700 25	25	118	50	62	12.5	25	3	Consulter
2 95 700 32	32	125	50	65	16	32	4	

QC série Longue

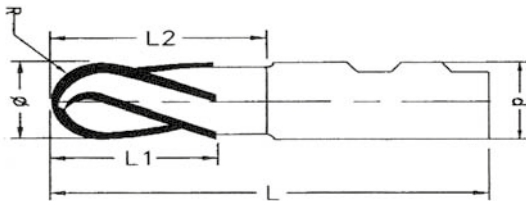

Code	Ø e8	L	L1	L2	R	d h6	Z	Prix Euros
2 95 700 16 L	16	113	30	63	8	20	3	Nous
2 95 700 20 L	20	131	40	75	10	25	3	
2 95 700 25 L	25	156	50	100	12.5	25	3	Consulter
2 95 700 32 L	32	185	50	125	16	32	4	

Cône Morse

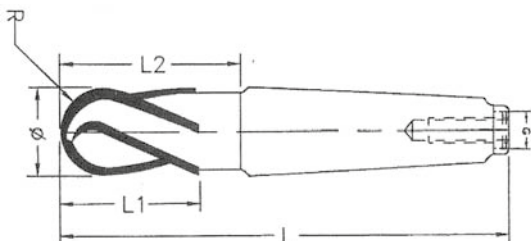

	Ø e8	L	L1	L2	R	CM	Z	Prix Euros
2 95 701 16	16	134	50	65	8	2	4	
2 95 701 20	20	145	40	59	10	3	4	
2 95 701 20	20	164	63	78	10	3	4	Nous
2 95 701 25	25	160	50	74	12.5	3	4	
2 95 701 32	32	200	63	91	16	4	4	Consulter
2 95 701 40	40	205	80	96	20	4	4	
2 95 701 40	40	225	100	116	20	4	4	

Fraise Conique

à alésage DIN 842

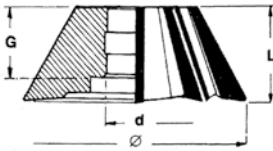

Code	Ø e8	L	G	α	d h8	Z	Prix €uros
2 95 804 50 60	50	16	10	60°	13	6	Nous
2 95 804 63 60	63	22	12	"	16	8	
2 95 804 80 60	80	29	15	"	22	8	consulter
2 95 804 100 60	100	37	21	"	27	10	
2 95 804 125 60	125	45	28	"	32	12	
2 95 804 50 55	50	15	10	55°	13	6	
2 95 804 63 55	63	21	12	"	16	8	Nous
2 95 804 80 55	80	27	15	"	22	8	
2 95 804 100 55	100	34	21	"	27	10	consulter
2 95 804 125 55	125	43	28	"	32	12	
2 95 804 50 50	50	15	10	50°	13	6	Nous
2 95 804 63 50	63	20	12	"	16	8	
2 95 804 80 50	80	25	15	"	22	8	consulter
2 95 804 100 50	100	32	21	"	27	10	
2 95 804 125 50	125	40	28	"	32	12	

QC Weldon din1835B

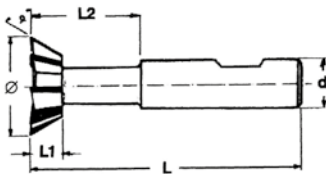

Code	Ø	L	L1	L2	α	CM	Z	Prix €uros
2 95 800 20 60	20	68	7	23	60°	12	6	Nous
2 95 800 25 60	25	70	8	25	"	12	6	
2 95 800 32 60	32	80	10	32	"	16	6	consulter
2 95 800 40 60	40	85	12	36	"	20	6	
2 95 800 20 50	20	68	6	23	50°	12	6	Nous
2 95 800 25 50	25	70	7	25	"	12	6	
2 95 800 32 50	32	80	9	32	"	16	6	consulter
2 95 800 40 50	40	85	11	36	"	20	6	

Fraise Rainure à T

QC Weldon DIN 1835B

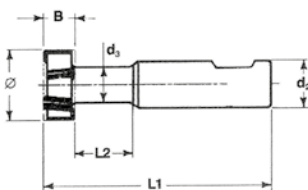

Code	Ø h11	L1	B	L2	d3	d2 h8	Z	Prix €uros
2 95 900 12.5	12.5	57	6	7	5	10	6	
2 95 900 16	16	62	8	10	7	10	6	
2 95 900 19	19	70	9	13	8	12	6	Nous
2 95 900 22	22	74	10	16	10	12	6	
2 95 900 25	25	82	11	17	12	16	6	consulter
2 95 900 28	28	85	12	20	13	16	6	

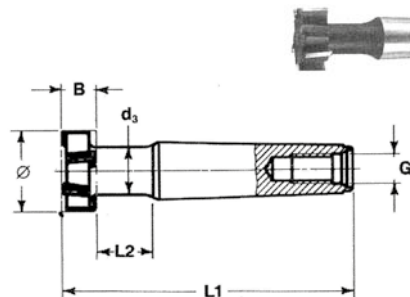

Code	Ø h11	L	B k11	L2	d3	G	CM	Z	Prix €uros
2 95 901 22	22	97	10	16	10	M 10	2	6	
2 95 901 25	25	100	11	17	12	M 10	2	6	
2 95 901 28	28	104	12	20	13	M 10	2	6	Nous
2 95 901 32	32	109	14	22	15	M 10	2	8	
2 95 901 36	36	131	16	24	17	M 12	3	8	consulter
2 95 901 40	40	136	18	27	19	M 12	3	8	
2 95 901 45	45	141	20	30	21	M 12	3	8	
2 95 901 50	50	147	22	34	23	M 12	3	8	
2 95 901 56	56	180	24	39	28	M 16	4	8	

Fraise 3 Tailles



Fraise 3 Tailles

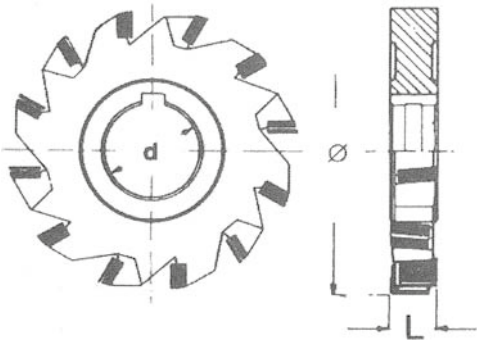

Code	∅ h 11	L	d h 7	Z	Prix €uros
2 95 904 63-6	63	6	22	8	Nous
2 95 904 63-8	"	8	"	"	
2 95 904 63-10	"	10	"	"	Consulter
2 95 904 63-12	"	12	"	"	
2 95 904 80-6	80	6	27	8	Nous
2 95 904 80-8	"	8	"	"	
2 95 904 80-10	"	10	"	"	Consulter
2 95 904 80-12	"	12	"	"	
2 95 904 100-6 27	100	6	27	10	
2 95 904 100-8 27	"	8	"	"	
2 95 904 100-10 27	"	10	"	"	Nous
2 95 904 100-12 27	"	12	"	"	
2 95 904 100-14 27	"	14	"	"	Consulter
2 95 904 100-16 27	"	16	"	"	
2 95 904 100-6 32	100	6	32	10	
2 95 904 100-8 32	"	8	"	"	
2 95 904 100-10 32	"	10	"	"	Nous
2 95 904 100-12 32	"	12	"	"	
2 95 904 100-14 32	"	14	"	"	Consulter
2 95 904 100-16 32	"	16	"	"	
2 95 904 125-6	125	6	32	12	
2 95 904 125-8	"	8	"	"	
2 95 904 125-10	"	10	"	"	Nous
2 95 904 125-12	"	12	"	"	
2 95 904 125-14	"	14	"	"	Consulter
2 95 904 125-16	"	16	"	"	
2 95 904 125-18	"	18	"	"	
2 95 904 125-20	"	20	"	"	
2 95 904 160-10	160	10	40	16	
2 95 904 160-12	"	12	"	"	
2 95 904 160-14	"	14	"	"	Nous
2 95 904 160-16	"	16	"	"	
2 95 904 160-18	"	18	"	"	Consulter
2 95 904 160-20	"	20	"	"	
2 95 904 200-14	200	14	40	20	Nous
2 95 904 200-16	"	16	"	"	
2 95 904 200-18	"	18	"	"	Consulter

Alésoirs Creux Carbure Brasé



à alésage conique 1/30

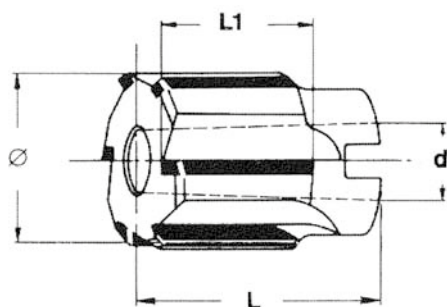

Code	Ø h7	L	L1	d	Z	Prix €uros
2 32 2 20	20	45	30	10	6	
2 32 2 22	22	"	"	"	"	
2 32 2 24	24	"	"	13	"	
2 32 2 25	25	"	"	"	"	
2 32 2 26	26	"	"	"	"	
2 32 2 28	28	"	"	"	"	
2 32 2 30	30	"	"	16	"	
2 32 2 31	31	"	"	"	"	
2 32 2 32	32	"	"	"	"	
2 32 2 33	33	"	"	"	"	
2 32 2 34	34	"	"	"	"	
2 32 2 35	35	"	"	"	"	
2 32 2 36	36	50	"	"	"	
2 32 2 37	37	"	"	"	"	
2 32 2 38	38	"	"	"	"	
2 32 2 39	39	"	"	"	"	
2 32 2 40	40	"	"	"	"	Nous
2 32 2 42	42	"	"	19	8	
2 32 2 43	43	"	"	"	"	consulter
2 32 2 44	44	"	"	"	"	
2 32 2 45	45	"	"	"	"	
2 32 2 46	46	56	"	"	"	
2 32 2 47	47	"	"	"	"	
2 32 2 48	48	"	"	"	"	
2 32 2 49	49	"	"	"	"	
2 32 2 50	50	"	"	"	"	
2 32 2 52	52	"	"	22	10	
2 32 2 54	54	63	"	"	"	
2 32 2 55	55	"	"	"	"	
2 32 2 58	58	"	"	"	"	
2 32 2 60	60	"	"	"	"	
2 32 2 62	62	"	"	27	"	
2 32 2 63	63	"	"	"	"	
2 32 2 65	65	"	"	"	"	
2 32 2 68	68	71	"	"	"	
2 32 2 70	70	"	"	"	"	
2 32 2 72	72	"	"	32	12	
2 32 2 75	75	"	"	"	"	
2 32 2 80	80	"	"	"	"	
2 32 2 85	85	"	"	"	"	
2 32 2 90	90	"	40	40	"	
2 32 2 95	95	"	"	"	"	
2 32 2 100	100	"	"	"	"	
2 32 2 105	105	"	"	"	14	
2 32 2 110	110	"	"	"	"	
2 32 2 115	115	"	"	"	"	
2 32 2 120	120	"	"	"	"	

Alésoirs QC



QC din 8050

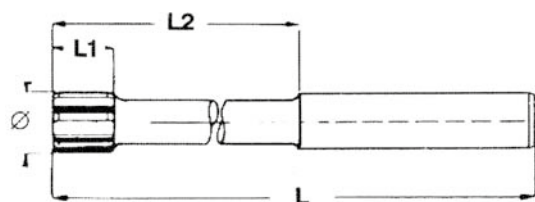

Code	Ø e8	L	L1	L2	QC	Z	Prix Euros
2 32 2 5 QC	5	100	12	70	5	4	
2 32 2 6 QC	6	100	12	70	6	4	
2 32 2 7 QC	7	100	16	70	8	4	Nous
2 32 2 8 QC	8	118	16	85	8	4	
2 32 2 9 QC	9	125	20	85	10	4	consulter
2 32 2 10 QC	10	132	20	90	10	4	
2 32 2 11 QC	11	132	20	90	12	4	
2 32 2 12 QC	12	150	20	100	12	6	
2 32 2 13 QC	13	160	20	110	14	6	
2 32 2 14 QC	14	170	20	115	14	6	
2 32 2 15 QC	15	170	20	115	16	6	
2 32 2 16 QC	16	180	25	120	16	6	
2 32 2 17 QC	17	190	25	130	18	6	
2 32 2 18 QC	18	190	25	130	18	6	
2 32 2 19 QC	19	200	25	130	20	6	
2 32 2 20 QC	20	200	25	130	20	6	

Alésoirs Cône Morse



Cône Morse

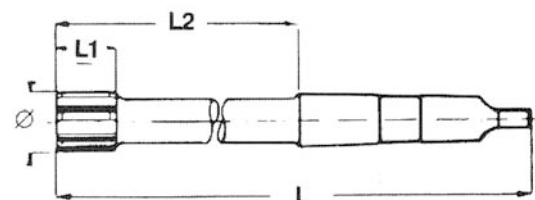

Code	Ø h7	L	L1	L2	CM	Z	Prix Euros
2 32 2 5 CM	5	170	12	104	1	4	
2 32 2 6 CM	6	170	12	104	"	"	
2 32 2 7 CM	7	170	16	104	"	"	
2 32 2 8 CM	8	170	16	104	"	"	
2 32 2 9 CM	9	170	20	104	"	"	
2 32 2 10 CM	10	170	20	104	"	"	
2 32 2 11 CM	11	170	20	104	"	"	
2 32 2 12 CM	12	182	20	116	"	6	
2 32 2 13 CM	13	182	20	116	"	"	
2 32 2 14 CM	14	189	20	123	"	"	
2 32 2 15 CM	15	204	20	124	2	"	
2 32 2 16 CM	16	210	25	130	"	"	
2 32 2 17 CM	17	214	25	134	"	"	
2 32 2 18 CM	18	219	25	139	"	"	
2 32 2 19 CM	19	223	25	143	"	"	
2 32 2 20 CM	20	228	25	148	"	"	
2 32 2 21 CM	21	228	25	148	"	"	Nous
2 32 2 22 CM	22	237	25	157	"	"	
2 32 2 23 CM	23	237	25	157	"	"	consulter
2 32 2 24 CM	24	268	25	169	3	"	
2 32 2 25 CM	25	268	25	169	"	"	
2 32 2 26 CM	26	273	25	174	"	"	
2 32 2 27 CM	27	277	30	178	"	8	
2 32 2 28 CM	28	277	30	178	"	"	
2 32 2 29 CM	29	281	30	182	"	"	
2 32 2 30 CM	30	281	30	182	"	"	
2 32 2 31 CM	31	281	30	182	"	"	
2 32 2 32 CM	32	281	30	182	"	"	
2 32 2 33 CM	33	281	30	182	"	"	
2 32 2 34 CM	34	310	30	186	4	"	
2 32 2 35 CM	35	310	30	186	"	"	
2 32 2 36 CM	36	310	30	186	"	"	
2 32 2 37 CM	37	310	30	186	"	"	
2 32 2 38 CM	38	310	30	186	"	"	
2 32 2 39 CM	39	310	30	186	"	"	
2 32 2 40 CM	40	310	30	186	"	"	

evatec tools®

Solutions sur mesure pour votre usinage
Machining solutions especially for you

CARBURE



PCBN / PCD



AÉRONAUTIQUE



TOURNAGE



USINAGE DE TROUS

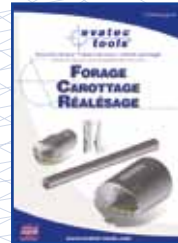

ATTACHEMENTS

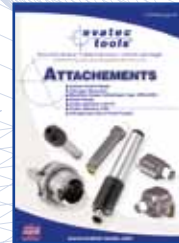

FRAISAGE

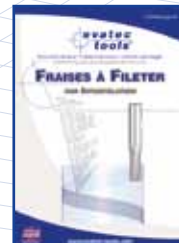
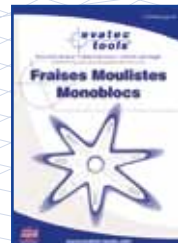

MÉTIERS / SPÉCIFIQUES



Téléchargez nos catalogues sur www.evatec-tools.com

Download our CATALOGS on www.evatec-tools.com

evatools® evamet® carbex® gmo®
coriatec® create outillage®

12, rue des Terres Rouges - Z.I. Metzange - 57100 Thionville
Tél. : 03 82 88 61 61 - E-mail : evatec@evatec-tools.fr

www.evatec-tools.com

