



Solutions sur mesure pour votre usinage
Machining solutions especially for you

FRAISES MP

Plaquette PRD



■ Fraise à Copier Mono-Plaquette

Type MP

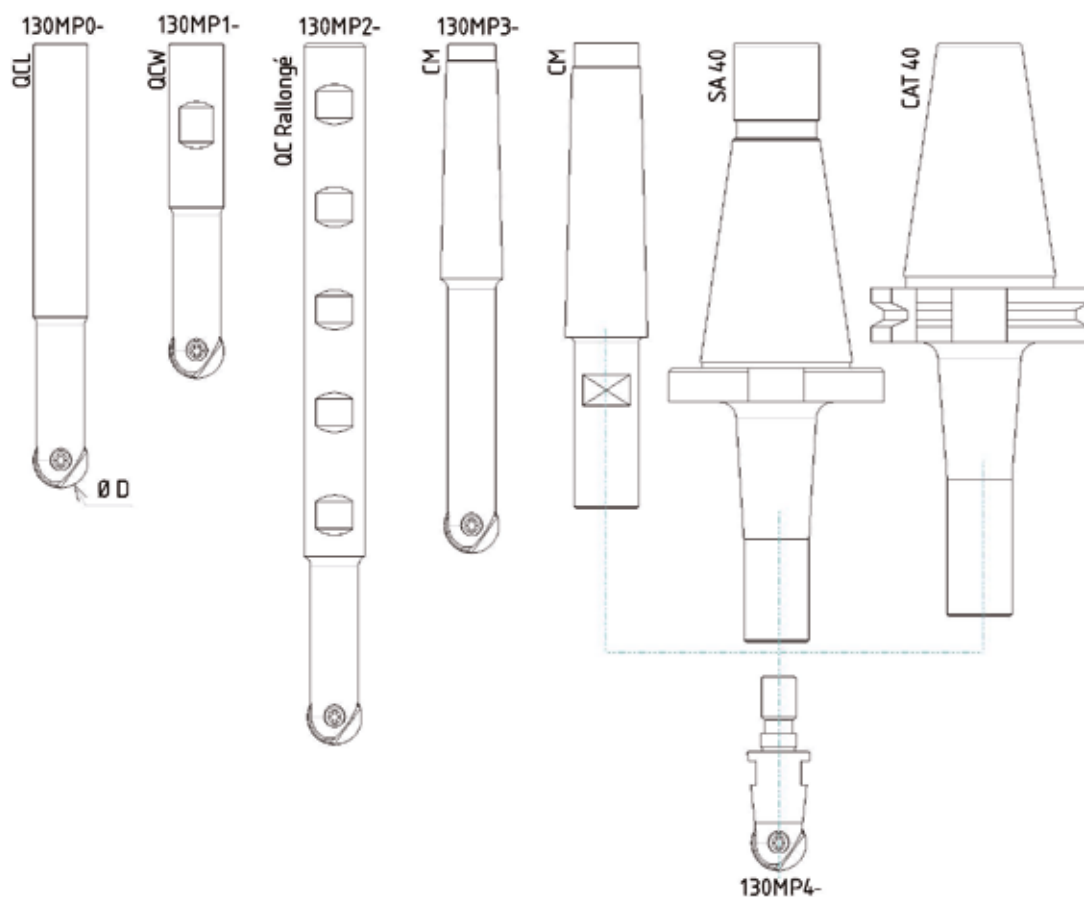

Fraise à copier type MP					
Ø D	Ref. commande N° Article	Attachement	Pages	Ref. commande Code plaq.	 Plaquette
10	130MP01	QC Ø12	3	Voir tableau Page 7	PRD 10
	130MP11	QCW Ø12	3		
	130MP21	QC Rallongé Ø18 (4 plats)	4		
	130MP3103	CM 2 taraudé	5		
	130MP3106				
12	130MP02	QC Ø12	3	Voir tableau Page 7	PRD 12
	130MP12	QCW Ø12	3		
	130MP22	QC Rallongé Ø18 (4 plats)	4		
	130MP3203	CM 2 taraudé	5		
	130MP3206				
	130MP3210				
16	130MP03	QC Ø16	3	Voir tableau Page 7	PRD 16
	130MP13	QCW Ø16	3		
	130MP23	QC Rallongé Ø18 (5 plats)	4		
	130MP3304	CM 2 taraudé	5		
	130MP3308				
	130MP3312				
130MP43	A visser M10	6			
20	130MP04	QC Ø20	3	Voir tableau Page 7	PRD 20
	130MP14	QCW Ø20	3		
	130MP24	QC Rallongé Ø18 (5 plats)	4		
	130MP3404	CM 3 taraudé	5		
	130MP3408				
	130MP3412				
	130MP44	A visser M10	6		

■ Fraise à Copier Mono-Plaquette

QC Lisse - Weldon

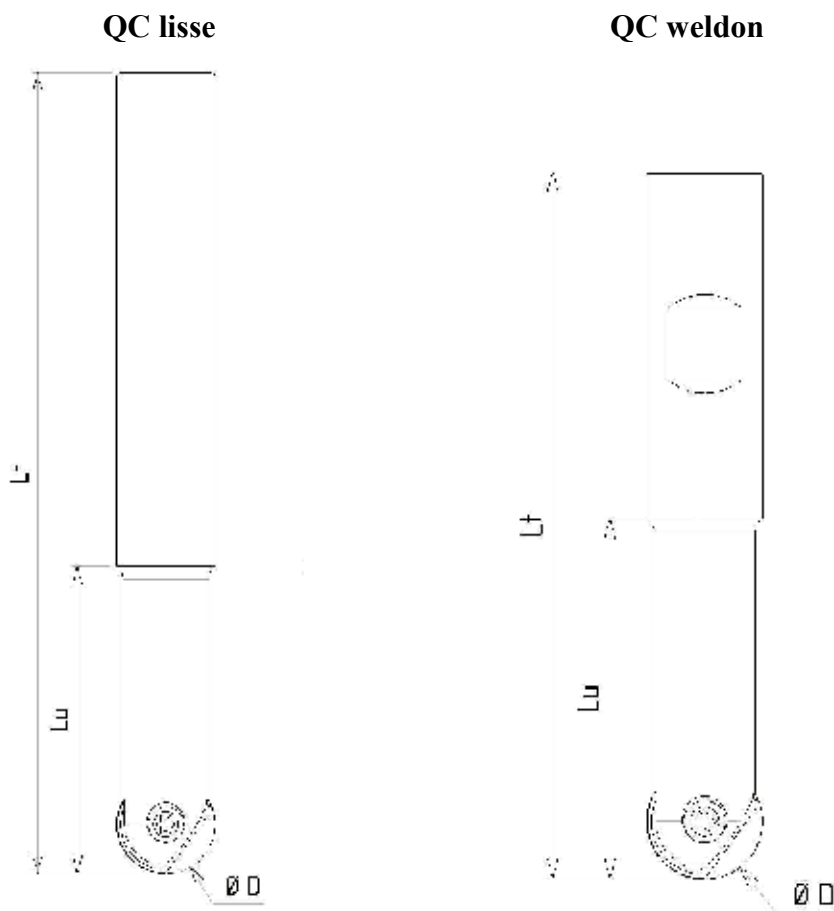

Fraise à copier type MP / QC lisse - weldon							
Ø D	Ref. commande N° Article	Attachement	Lu	Lt	Angle maxi	Ref. commande Code plaq.	Plaquette
10	130MP01	QC Ø12	35 à 85	115	2°	Voir tableau Page 7	PRD 10
	130MP11	QCW Ø12	35	80	-		
12	130MP02	QC Ø12	40 à 90	120	-	Voir tableau Page 7	PRD 12
	130MP12	QCW Ø12	40	85	-		
16	130MP03	QC Ø16	50 à 100	130	-	Voir tableau Page 7	PRD 16
	130MP13	QCW Ø16	50	98	-		
20	130MP04	QC Ø20	60 à 120	160	-	Voir tableau Page 7	PRD 20
	130MP14	QCW Ø20	60	110	-		

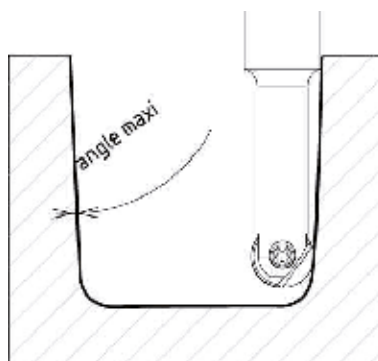

■ Fraise à Copier Mono-Plaquette

QC Rallongé

	Ref. commande N° Article	Alésage	L	Attachement	Adapter pour
Adapteur SA 40	142041806	Ø 18	60	SA 40 din 2080	QC 4plats
Adapteur CAT 40	142141806	"	60	CAT 40 din 69871	QC 4plats
Adapteur SA 50	142051806	"	60	SA 50 din 2080	QC 4 et 5 plats
Adapteur CAT 50	142151808	"	80	CAT 50 din 69871	QC 4 et 5 plats

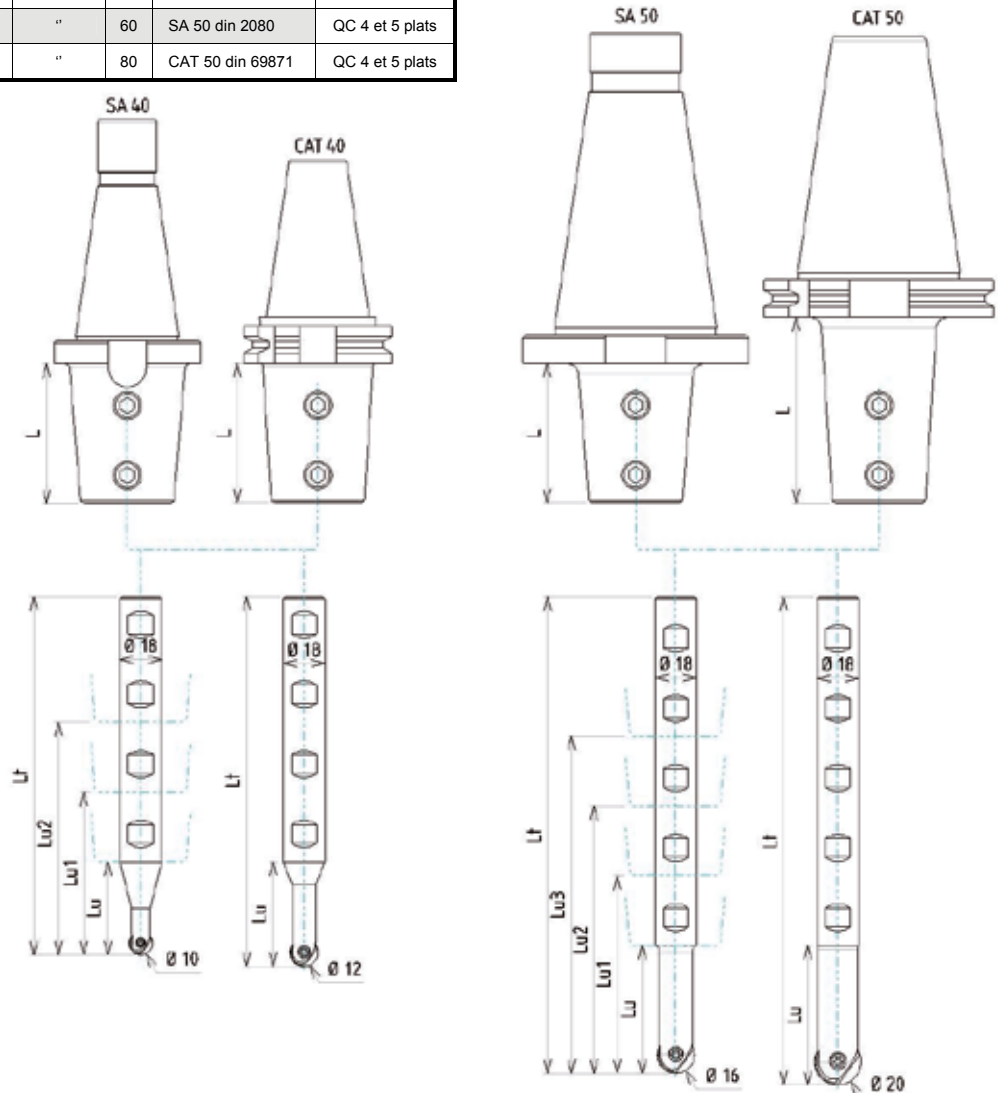

Fraise à copier type MP / QC Rallongé										
Ø D	Ref. commande N° Article	Attachement	Lu	Lu1	Lu2	Lu3	Lt	Angle maxi	Ref. commande	Plaquette
10	130MP21	QC Rallongé Ø18 (4 plats)	40	70	100	-	154	6.5°	Voir tableau Page 7	PRD 10
12	130MP22	QC Rallongé Ø18 (4 plats)	45	75	105	-	159	4.5°	Voir tableau Page 7	PRD 12
16	130MP23	QC Rallongé Ø18 (5 plats)	55	85	115	145	205	1.5°	Voir tableau Page 7	PRD 16
20	130MP24	QC Rallongé Ø18 (5 plats)	60	90	110	150	210	-	Voir tableau Page 7	PRD 20

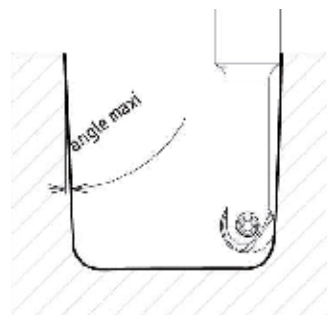

■ Fraise à Copier Mono-Plaquette

Cône Morse

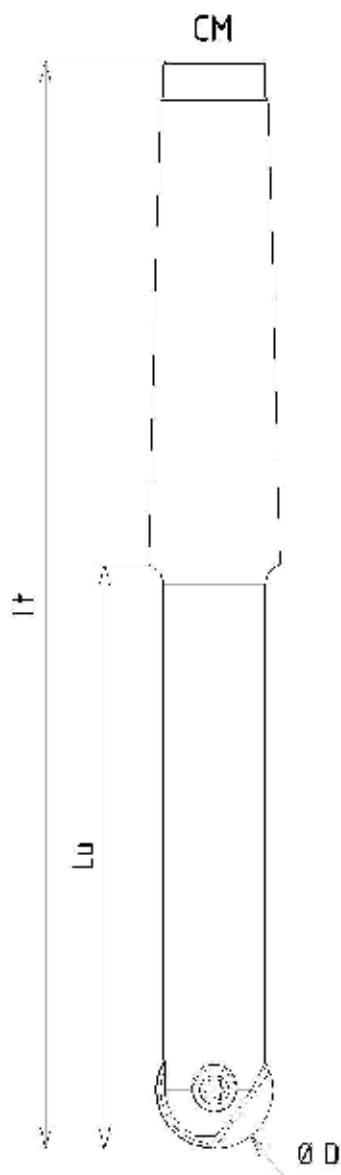

Fraise à copier type MP / CM						
Ø D	Ref. commande N° Article	Attachement	Lu	Lt	Ref. commande Code plaq.	Plaquette
10	130MP3103	CM 2 taraudé	30	99	Voir tableau Page 7	PRD 10
	130MP3106		60	129		
12	130MP3203	CM 2 taraudé	30	99	Voir tableau Page 7	PRD 12
	130MP3206		60	129		
16	130MP3304	CM 2 taraudé	40	109	Voir tableau Page 7	PRD 16
	130MP3308		80	149		
	130MP3312		120	189		
20	130MP3404	CM 3 taraudé	40	126	Voir tableau Page 7	PRD 20
	130MP3408		80	166		
	130MP3412		120	206		

■ Fraise à Copier Mono-Plaquette À Visser

Les adaptateurs à visser M10						
Code article	Lu	L t	L1	Ø d1	Ø d2	attachement
14145M1015	70	150	-	19	-	QC Ø 20 lisse
14145M1020	80	200	-	19	-	QC Ø 20 lisse
14133M1005	50	136	-	19	-	CM 3
14133M1008	80	166	40	19	24	CM 3
14114M1008	80	167.5	40	19	25	CAT 40 din 69871
14104M1008	70	175	30	19	24	SA 40 din 2080

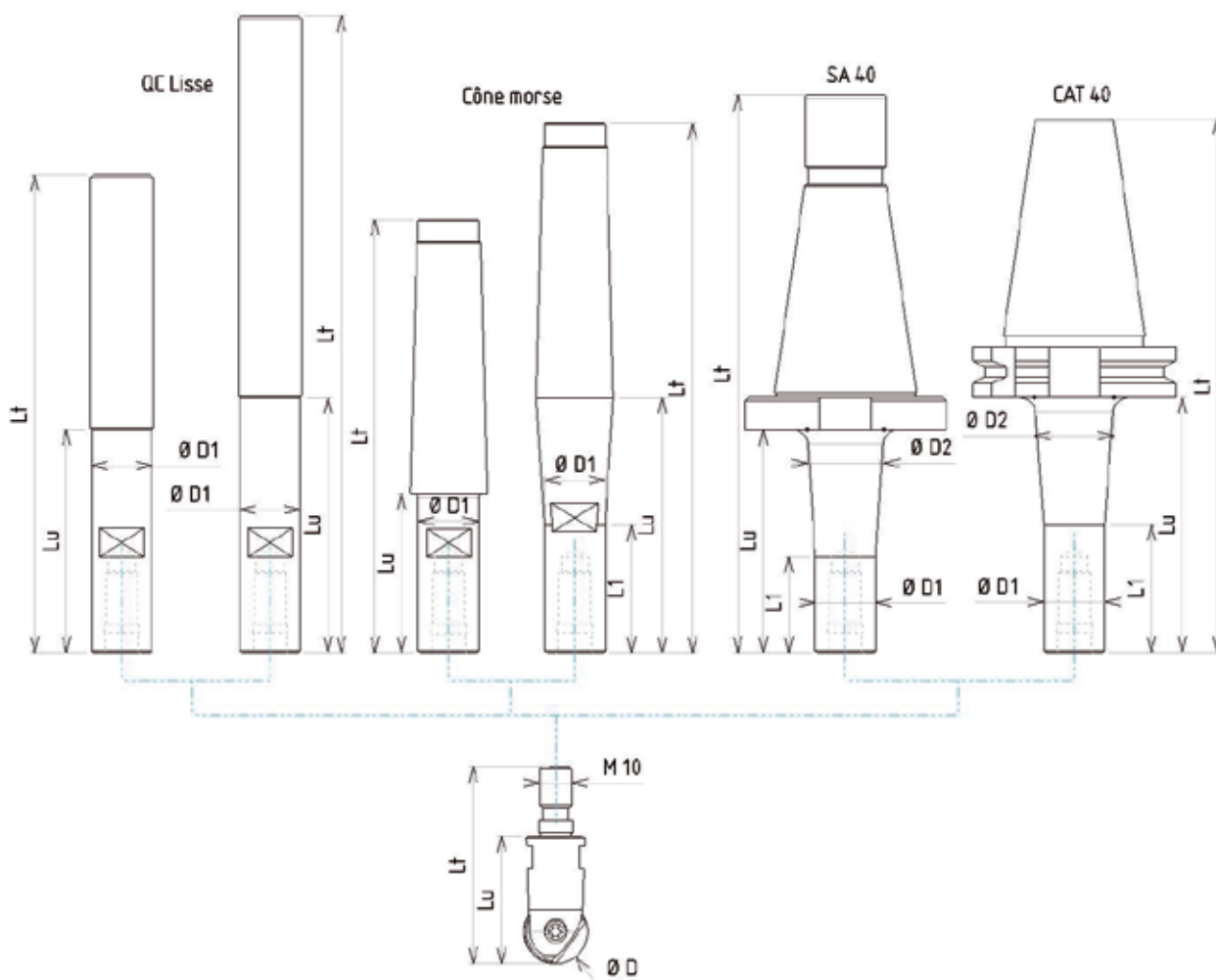



Fraise à copier type MP / A visser						
Ø D	Ref. commande N° Article	Attachement	Lu	Lt	Ref. commande Code plaq.	Plaquette
16	130MP43	A visser M10	35	57	Voir tableau Page 7	PRD 16
20	130MP44	A visser M10	40	62	Voir tableau Page 7	PRD 20

■ Fraise à Copier Mono-Plaquette

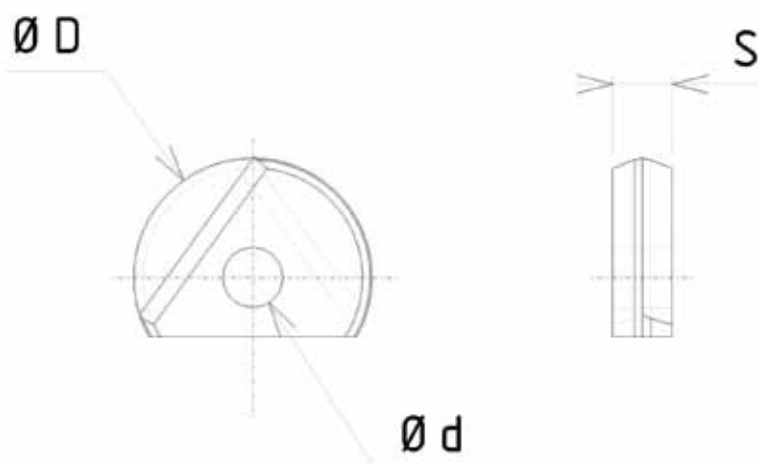
Plaquette



Fraise à copier type MP / Plaquette										
Ref. commande Code plaq.	 Plaquette	Ø D	Ø d	S	Nuance	Tarif *	 Ref. Commande Code Vis	Vis	 Ref. commande Code Tournevis	Torx N°
	PRD 8 REP 4	8			MG10	S/D	VRD 8		263 ...	
					MG10X	S/D				
01833983320	PRD 10 REP 4	10	3	2.6	MG10	S/D	VRD 10	M 3	263 ...	8
01833983327X					MG10X	S/D				
01833982320	PRD 12 REP 4	12	3.5	3	MG10	S/D	VRD 12	M 3,5	263 ...	8
01833982327X					MG10X	S/D				
01833981320	PRD 16 REP 4	16	4	4	MG10	S/D	VRD 16	M 4	263 ...	15
01833981327X					MG10X	S/D				
01832979320	PRD 20 REP 4	20	5	5	MG10	S/D	VRD 20	M 5	263 ...	20
01832979327X					MG10X	S/D				
	PRD 25 REP 4	25			MG10	S/D	VRD 25			
					MG10X	S/D				
	PRD 32 REP 4	32			MG10	S/D	VRD 32			
					MG10X	S/D				
	PRD 40 REP 4	40			MG10	S/D	VRD 40			
					MG10X	S/D				

Toutes ces plaquettes peuvent être fournies avec revêtement DLC diamant et avec insert CBN ou PCD.

* S/D → sur devis

evatec tools®

Solutions sur mesure pour votre usinage
Machining solutions especially for you

CARBURE



PCBN / PCD



AÉRONAUTIQUE



TOURNAGE



USINAGE DE TROUS

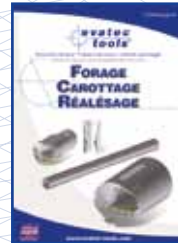

ATTACHEMENTS

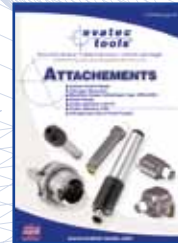

FRAISAGE

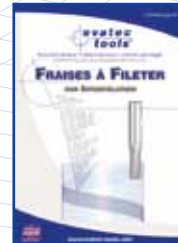

MÉTIERS / SPÉCIFIQUES



Téléchargez nos catalogues sur www.evatec-tools.com

Download our CATALOGS on www.evatec-tools.com

evatools® evamet® carbex® gmo®
coriatec® create outillage®

12, rue des Terres Rouges - Z.I. Metzange - 57100 Thionville
Tél. : 03 82 88 61 61 - E-mail : evatec@evatec-tools.fr

www.evatec-tools.com

